

Varenummer: 20516ND4327M5

Beskrivelse: E+G Magnet m/indv. gevind GN 51.6-ND-43-27-M5
Neodym, jern, bor - 80° C, 85N

Mål

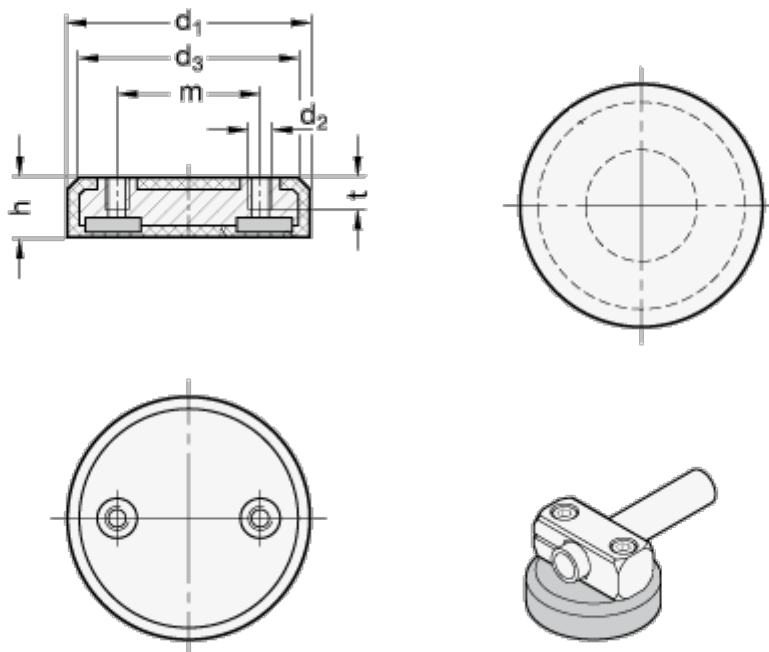

d1	= 43
d2	= M5
d3	= 39
h	= 10.3
Holdekraft N	= 85
m	= 27
t	= 7